

MHI
Copy 3

FM 23-25

WAR DEPARTMENT BASIC FIELD MANUAL

BAYONET

WAR DEPARTMENT 7 SEPTEMBER 1943

BAYONET

THIS manual supersedes FM 23-25, 2 January 1940. Attention is directed to FM 21-7 for details as to how appropriate Training Films and Film Strips are intended to be used and how they are made available for use during training with the bayonet.

WAR DEPARTMENT

WASHINGTON 25, D. C., 7 September 1943.

FM 23-25, War Department Basic Field Manual, Bayonet, is published for the information and guidance of all concerned.

[A.G. 300.7 (23 Jul 43).].

BY ORDER OF THE SECRETARY OF WAR:

G. C. MARSHALL,

Chief of Staff.

OFFICIAL:

J. A. ULIO,

Major General,

The Adjutant General.

DISTRIBUTION:

R 2, 4, 44 (5), 7 (15); Bn 2, 4, 7,
19, 44 (5); C 2, 4, 44 (10), 7,
19, (20), 9 (2); IC and H 5 (10).

(For explanation of symbols see FM 21-6.)

TABLE OF CONTENTS

Section	Par.	Page
---------	------	------

I. GENERAL:

The spirit of the bayonet	1	1
Uses of the bayonet	2	1
Principles of bayonet fighting	3	2
Developing bayonet fighter	4	2

II. POSITIONS AND MOVEMENTS:

General	5	3
Guard	6	4
High port	7	5
Whirl	8	7
Long thrust	9	7
Withdrawal from long thrust	10	9
Short thrust and withdrawal	11	11
Parries	12	11
Butt strokes and slashes	13	14

III. GROUP ASSAULT TACTICS:

General	14	20
Group assault tactics	15	21

IV. BAYONET AND KNIFE DISARMING:

General	16	26
Bayonet disarming	17	27
Knife disarming	18	29

V. ADVICE TO INSTRUCTORS:

The instructor	19	34
Conduct of classes	20	35
Sequence of training	21	37
Conduct of training	22	40
Training aids	23	41
Training in group assault tactics	24	57
Assault course	25	58
Bayonet and knife disarming	26	60

SECTION I

GENERAL

1. THE SPIRIT OF THE BAYONET The will to meet and destroy the enemy in hand-to-hand combat is the spirit of the bayonet. It springs from the fighter's confidence, courage, and grim determination, and is the result of vigorous training. Through training, the fighting instinct of the individual soldier is developed to the highest point. The will to use the bayonet first appears in the trainee when he begins to handle it with facility, and increases as his confidence grows. The full development of his physical prowess and complete confidence in his weapon culminates in the final expression of the spirit of the bayonet—fierce and relentless destruction of the enemy. For the enemy, demoralizing fear of the bayonet is added to the destructive power of every bomb, shell, bullet, and grenade which supports and precedes the bayonet attack.

2. USES OF THE BAYONET a. A determined enemy may not be driven from his position by fire alone. Making full use of cover and concealment, he will often remain in his position until driven out in hand-to-hand combat. The bayonet or the threat of it, therefore, is the ultimate factor in every assault.

b. At night, on infiltration missions, or whenever secrecy must be preserved, the bayonet is the weapon of silence and surprise.

c. In close combat, when friend and foe are too closely

intermingled to permit the use of bullets or grenades, the bayonet is the primary weapon of the infantry soldier.

3. PRINCIPLES OF BAYONET FIGHTING a. The bayonet is an offensive weapon. With it, aggressiveness wins. Hesitation, preliminary maneuvering, and fencing are fatal. The delay of a fraction of a second may mean death.

b. The bayonet fighter attacks in a fast, relentless assault until his opponent is destroyed. He takes instant advantage of any opening; if the enemy gives no opening, the attacker makes one by parrying his opponent's weapon and driving blade or butt into him with killing force.

c. As the throat area is especially sensitive to attack by the bayonet, an opponent will act instinctively to protect this area from a thrust. By threatening his opponent's throat with the point of the bayonet, the attacker will frequently cause him to uncover other vulnerable parts of the body. Other sensitive parts frequently exposed to the attacker's thrust are the face, chest, abdomen, and groin.

4. DEVELOPING BAYONET FIGHTER From the outset bayonet training will be conducted with constant emphasis on developing proper form, quickness with the rifle and bayonet, footwork, and accuracy. Continued striving for these four essential qualities will develop the coördination, balance, speed, strength, and endurance that mark the expert bayonet fighter. Differences in conformation of individuals may require minor deviations from the prescribed bayonet technique. Those deviations which do not detract from the effectiveness of the individual's attack will be disregarded.

SECTION II

POSITIONS AND MOVEMENTS

5. GENERAL a. In assuming any position or executing any movement, the bayonet fighter relaxes the muscles not used directly in the effort. He holds the rifle firmly but without tenseness. Tense muscles induce fatigue and retard speed.

b. By proper emphasis in training, all movements become instinctive. The bayonet fighter strikes automatically at openings and presses the attack relentlessly. He avoids any fixed sequence of movements. He achieves balance in all his movements and constant readiness to strike instantly in any direction and to keep striking until his opponent has been destroyed. At all times he watches his opponent's bayonet and body. The positions and movements described in this section are designed to accomplish these ends.

c. The bayonet fighter's positions are GUARD, SHORT GUARD, and HIGH PORT. He executes the following movements: WHIRL, LONG THRUST, SHORT THRUST, WITHDRAWAL, PARRY RIGHT AND LEFT, VERTICAL AND HORIZONTAL BUTT STROKES, SMASH, and SLASH. The beginner learns these movements as separate actions. By training, however, he learns to execute them in varying combinations as swift, continuous actions.

6. GUARD a. TO ASSUME POSITION OF GUARD

- (1) Face the opponent.
- (2) Leading with the left foot, take a short step and space the feet laterally as well as in depth, toes pointing toward the opponent. Bending the knees slightly, incline the body slightly forward, hips level (fig. 1).
- (3) At the same time throw the rifle forward, point of the bayonet moving straight toward the opponent, and catch the rifle with both hands. This movement must be swift and sure.
- (4) Grasp the rifle with the left hand, palm against the left side of the rifle at the most convenient point forward of the balance, usually just in front of the lower band, with the left arm slightly bent. With the right hand, palm to the left, grasp the small of the stock. To prevent bruising the right forefinger, hold the small of the



FIGURE 1.—Guard.

BAYONET

stock so that the finger is not touching the trigger guard. Hold the under and inside portion of the forearm against the comb of the stock, with the base of the butt snugly against the side of the hip. Hold the rifle firmly but not rigidly with both hands, without canting it. Point the bayonet at the base of the opponent's throat.

(5) Balance the weight of the body on both legs, ready for instant movement in any direction.

(6) Keep the eyes on the opponent's bayonet and body.

b. **SHORT GUARD** To assume the position of **SHORT GUARD** from **GUARD**, bring the rifle back so that the right hand is at the right hip. This is a convenient carrying position when moving through dense woods, brush, trenches, around buildings, or when the enemy may be encountered suddenly at very close quarters.

c. COMMON ERRORS

(1) Feet not separated in a well-balanced stance.

(2) Hips not facing straight forward.

(3) Body too erect.

(4) Right forearm not firmly pressing comb of stock against the body.

(5) Left arm straight, or bent too much.

(6) Rifle gripped tensely, restraining freedom of movement.

(7) Point of bayonet too high.

7. HIGH PORT a. **TO ASSUME POSITION OF HIGH PORT** From the position of **GUARD**, without changing the position of the feet or the grasp of the hands on the rifle, carry the piece diagonally across the body, sling to the front, until the left wrist is level with and in front of the left shoulder (fig. 2).

b. EMPLOYMENT IN JUMPING TRENCHES AND HURDLING OBSTACLES

(1) To jump holding the rifle at high port, throw the piece sharply upward and forward from the HIGH PORT on taking off, and bring it back on landing. This jumping will also be practiced with the position of the piece approximately maintained with the left hand alone, leaving the right hand free to assist in clearing the obstacle.

(2) To jump holding the rifle in the GUARD position, snap it up quickly on taking off, maintaining the grasp of the hands, and start the piece down from the highest



FIGURE 2.—High port.

point in the jump. The piece will be snapped down to GUARD position as the jumper alights.

8. WHIRL To execute the WHIRL from the position of GUARD, bring the piece to HIGH PORT, whirl to the left about by pivoting on the ball of the left (leading) foot, and resume the position of GUARD.

9. LONG THRUST a. EXECUTION

(1) To execute the LONG THRUST from the GUARD position, advance the rear foot and lunge forward, extending the entire body (fig. 3).

(2) Complete the extension of the body as the rear foot strikes the ground. During this movement drive the rifle, gripped firmly by both hands and guided by the left hand, forcefully in a straight line at the opponent's throat or other opening on his body. Quickly extend the left arm to its full length so that the bayonet *darts* toward the target. At the instant of full extension, hold the butt of the rifle inside of and pressed against the right forearm, bend the leading knee, incline the body well forward, and straighten the rear leg.

(3) Keep the eyes on the point of attack during the entire movement.

(4) If the thrust is evaded, move in swiftly with another thrust, or butt stroke. Retraction and recovery after the thrust will be instantaneous. There must never be any lingering in the extended position.

(5) The power of the LONG THRUST comes from the arms, shoulders, back, legs, and weight of the body. The distance from which the LONG THRUST is launched de-

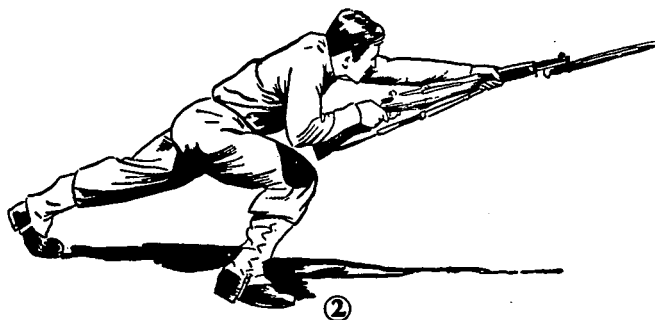

FIGURE 3.—Long thrust from position of guard.

BAYONET

depends on the reach and speed of advance of the attacker. The maximum distance for each individual is determined by trial at the thrusting dummies. It is imperative for each soldier to know his reach and be able to judge his attack distance accurately so that his thrust will reach the target. By increasing the number of steps, the soldier will be trained to execute the thrust with either foot forward.

b. COMMON ERRORS

- (1) "Telegraphing" the thrust by drawing the rifle back just before delivering the thrust.
- (2) Thrust made with the arms alone and not with the power of the legs and body.
- (3) Thrust accompanied by a slight slash, preventing straight forward penetration.
- (4) Point of bayonet carried too high, or at a lateral angle to target.
- (5) Butt not braced against inside of the right forearm.
- (6) Body not inclined far enough forward.
- (7) Loss of balance, caused by taking too long a step.
- (8) Leading knee not sufficiently bent.
- (9) Eyes not on the point of attack.

10. WITHDRAWAL FROM LONG THRUST

a. EXECUTION To withdraw if the LONG THRUST has been made with the right foot forward, advance the left foot and jerk the rifle straight back along the line of penetration with the force and weight of the entire body, carrying the body to the rear by straightening the forward leg (fig. 4). If necessary, maintain balance by shifting the right foot to the rear. If the LONG THRUST has been

BASIC FIELD MANUAL

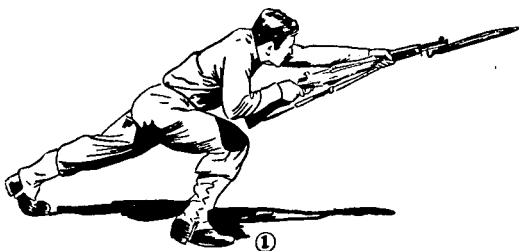

FIGURE 4.—Withdrawal from long thrust.

BAYONET

made with the left foot leading, bring up the right foot sufficiently to maintain balance, and withdraw in the same manner as above. If the opponent is down, place one foot on him and withdraw. In any event, withdraw *instantly*, prepare to execute the **SHORT THRUST** or a **BUTT STROKE** or assume the position of **GUARD** or **SHORT GUARD**. Do not linger in the extended position.

b. COMMON ERRORS

- (1) Not making the withdrawal vigorously, caused by using the arms alone to make the withdrawal.
- (2) Not withdrawing the bayonet back on the line of penetration, caused by allowing the butt of the rifle to drop.

11. SHORT THRUST AND WITHDRAWAL

a. **EXECUTION** Being in the **GUARD** or **SHORT GUARD** position, or on withdrawal from a **LONG THRUST**, execute the **SHORT THRUST** in the same manner as the **LONG THRUST**, except that the *leading* foot is advanced in lunging forward (fig. 5). The **SHORT THRUST** is used when an opponent is encountered suddenly or at a range too close for the **LONG THRUST**. Practice will include executing the **SHORT THRUST** with either the right or left foot forward.

b. **WITHDRAWAL** Withdrawal from a **SHORT THRUST** in the same manner as from a **LONG THRUST**. Upon completion of the withdrawal, recover to the **GUARD** position, or execute another thrust or butt stroke.

12. PARRIES a. **PURPOSE** The **PARRY** is an offensive blow to create an opening by beating the opponent's

FIGURE 5.—*Short thrust.*

bayonet out of the way. It is made by a forward and lateral movement of great force and speed. The lateral movement of the blade is limited to the extent necessary to beat the opponent's weapon clear of your body. The momentum of the PARRY is continued into a thrust or butt stroke. The position of the opponent's weapon will determine the direction of the parry. The parry invari-

BAYONET

ably will be made in the direction that will best create an opening for instant execution of a thrust or butt stroke.

b. EXECUTION

(1) PARRY RIGHT

(a) To PARRY RIGHT from the position of GUARD, lunge forward as in a LONG THRUST (fig. 6).

(b) At the same time, thrust the piece diagonally forward and to the right by straightening the left arm in the direction of the parry, moving the butt to the right and keeping the piece parallel to the GUARD position. Keep the comb of the stock pressed firmly against the under and inner surface of the right forearm. Limit the diagonally forward movement to beat the opponent's blade just clear of the body.

(c) Continue the PARRY into a LONG THRUST during



FIGURE 6.—Parry right.



FIGURE 7.—Parry left.

the same forward step. As the bayonet strikes the opponent's blade, beating it clear of the body, and at the instant the bayonet glances off of the opponent's weapon, drive it into him in the same continuous movement.

(d) To PARRY RIGHT preceding a SHORT THRUST, execute the movement as described above, making the PARRY just prior to the forward lunge with the forward foot.

(2) PARRY LEFT To PARRY LEFT, lunge forward as in the PARRY RIGHT, thrust the rifle forward and to the left so that the butt is approximately in front of the left groin, deflecting the opponent's bayonet clear of the body (fig. 7). The PARRY LEFT is followed by a thrust, or by a butt stroke in case the point of the bayonet is not on a line toward the opponent.

c. COMMON ERRORS

(1) Failure to use sufficient force and speed, caused by using the arms alone without the weight and momentum of the body.

(2) Making a wide sweeping movement, without any forward movement of the piece.

(3) Eyes not on the opponent's weapon.

13. BUTT STROKES AND SLASHES a. GENERAL

The bayonet fighter does not use butt strokes and slashes in combat when it is possible to use a thrust. But he can use them advantageously in many situations, particularly in close-in fighting when there is not enough room to deliver a thrust or immediately after a thrust that has been evaded. When using a butt stroke the fighter can often knee his opponent in the groin, trip

him, or kick him in the legs. Butt strokes and slashes lend themselves especially to fighting in trenches, woods, and brush, or in a general melee when lateral movements are restricted.

b. EXECUTION

(1) VERTICAL BUTT STROKE SERIES

(a) To make the vertical butt stroke from the GUARD position, step in with the rear foot and, at the same time, drive the butt forward and upward in a vertical arc to the groin, solar plexus, or chin. Put the force of the whole body into the blow (fig. 8). The vertical butt stroke may also be started from a crouched position so as to hit low points on the opponent's body while offering him a small, difficult target.

(b) SMASH If the opponent moves backward and the vertical butt stroke misses, step forward swiftly with the left foot (fig. 9) and drive the butt at his head, extending the arms fully forward, and advancing the right foot to retain balance.

(c) SLASH If the opponent again retreats out of butt range or falls, continue to advance, slashing diagonally downward with the bayonet. Guide the slash toward the junction of the neck and shoulder, hitting either this point or the head, throat, or arms. If the slash misses (note that a miss brings the movement close to the position of GUARD), continue the attack vigorously.

(2) HORIZONTAL BUTT STROKE SERIES

In this series the plane of the rifle and bayonet is horizontal instead of vertical.

(a) HORIZONTAL BUTT STROKE To make the horizontal butt stroke from the GUARD position (fig. 11),

BASIC FIELD MANUAL

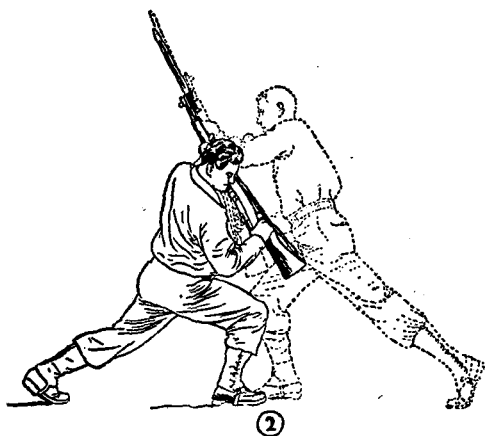

FIGURE 8.—Vertical butt stroke.

BAYONET

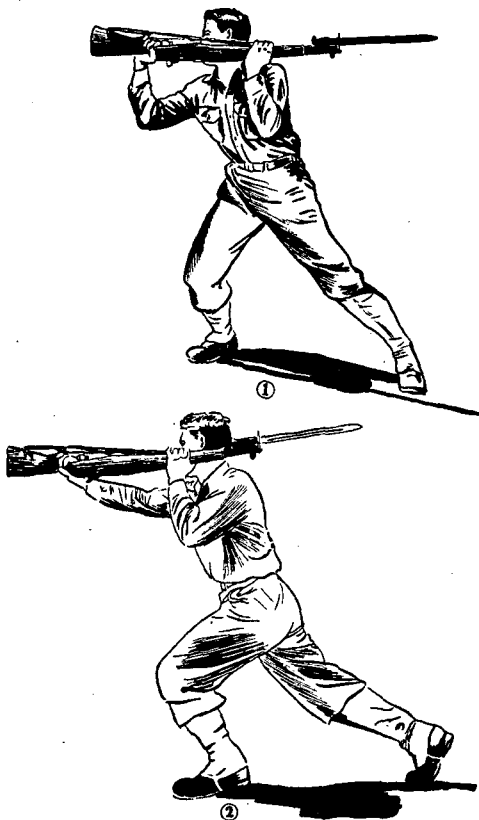

FIGURE 9.—Smash following vertical butt stroke.

drive in vigorously, advancing the rear foot, and swing the butt diagonally upward through an arc to the opponent's head or body.

(b) SMASH If the horizontal butt stroke misses because the opponent has moved backward, deliver a

smash, maintaining the butt in the same horizontal position.

(c) SLASH If the smash misses, continue the attack with a slash, executing the movement as directed in the vertical butt stroke series.

c. COMMON ERRORS

(1) Failure to reach out at the opponent.



FIGURE 10.—Slash following smash.

BAYONET

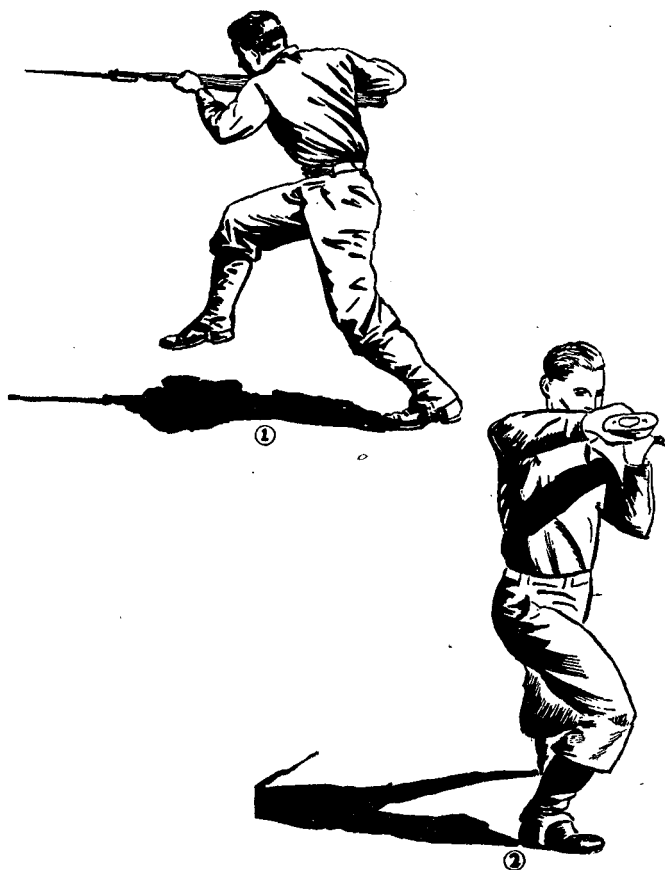

FIGURE 11.—Horizontal butt stroke.

- (2) The force of the arm and body not in the movement, occurring when the plane of the bent right arm is not in the plane of the rifle and bayonet.
- (3) Insufficient speed.

SECTION III

GROUP ASSAULT TACTICS

14. GENERAL a. While actual bayonet fighting is individual, each man must understand from the very first that he is fighting for his organization and not for himself alone. When one body of soldiers assaults the position of another group, none can know which enemy he will engage until the attackers get within bayonet range. No man knows whether he will be suddenly confronted and attacked by several enemies at the same time, or if one of several friends will confront a single enemy. The fighters who have the teamwork, skill, and presence of mind to capitalize quickly on such inequalities will gain momentary numerical advantage.

b. If two soldiers, suddenly confronting one of the enemy, are able to put him out of action in a few seconds, they can quickly turn on another opponent. Such systematic assaults occurring in the first critical seconds of meeting in hand-to-hand fighting may reduce the enemy's initial strength by many men. In another few seconds these tactics can operate with annihilating effect on the remainder of the enemy. However, if assault groups lack a prearranged system of team attack, a single enemy

BAYONET

can hold off a pair of bayonet fighters for a few seconds, by which time one of his comrades may rush to his assistance and end the two-to-one advantage which existed.

c. To be effective, group assault tactics must be simple and flexible, since it is impossible to predict what the exact situation will be until the opposing fighters are within a few paces of each other. Movements are fast and automatic, for the quickness and turmoil of hand-to-hand fighting will rarely permit verbal coordination of attack.

15. GROUP ASSAULT TACTICS a. TWO AGAINST ONE

(1) APPROACH Two bayonet fighters, part of an assaulting echelon, approach a single enemy. Since these fighters cannot know what the opponent will do, they cannot plan for coordinated action at this stage. Hence they advance directly forward on a run, neither one converging on the opponent.

(2) CONTACT As the fighters get within bayonet range, one of them initially will be opposed by the single enemy. The selected man advances upon him in a frontal attack.

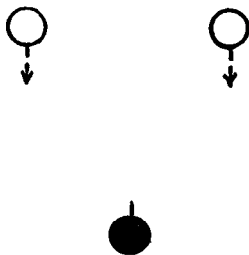

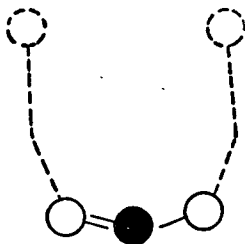

The other man quickly advances until opposite the opponent's flank and then turns sharply to strike his exposed flank or rear. (See also figs. 12 and 13.)

(3) ALTERNATIVE ATTACK If the enemy turns suddenly toward the flanking fighter to fend him off, he thereby exposes himself to the fighter making the frontal attack. This man strikes instantly.

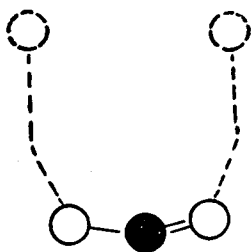

In any such coordinated attack, the man who makes the kill usually is the one who is not closely engaged with the enemy's bayonet (fig. 14). The entire operation is carried out in a few seconds. The approach, contact, and attack flow into one continuous assault.

BAYONET

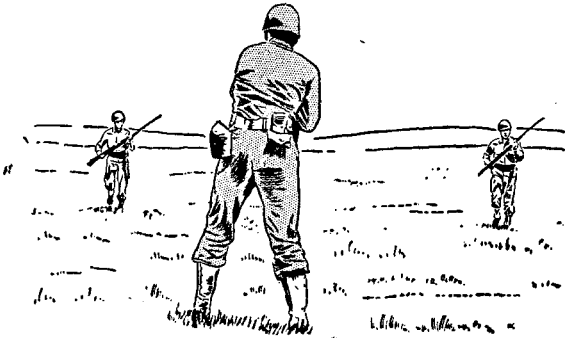

FIGURE 12.—Group assault tactics, two against one—the approach.

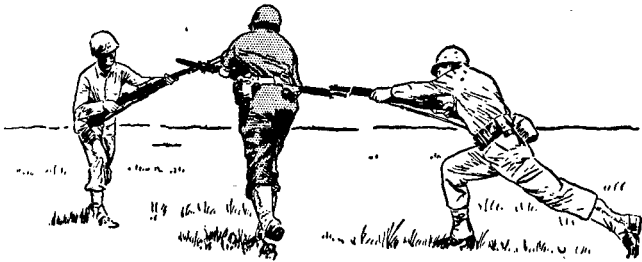

FIGURE 13.—Group assault tactics, two against one—contact.

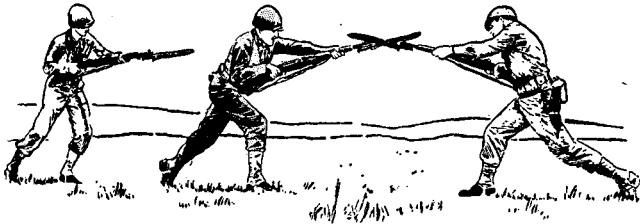
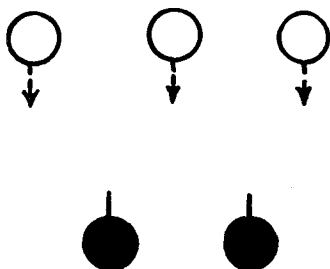

FIGURE 14.—Group assault tactics, two against one—alternative attack.

b. THREE AGAINST TWO

(1) APPROACH Three attackers approach two of the enemy. At this stage none of the three knows who will be engaged initially by the enemy. They advance directly forward at a run.



(2) CONTACT As they get within bayonet range, two of the attackers will normally be engaged by two of the enemy. One attacker is thus left momentarily free. He continues directly forward until opposite the flank of the nearest or most accessible enemy, at which point he veers suddenly toward that enemy and strikes him in the exposed side, as in the two-against-one maneuver. The other two attackers maintain their frontal attacks. With one enemy disposed of, the other enemy is struck in the flank by the first free attacker who can reach him. If either enemy being attacked on his flank turns to defend himself, he leaves himself open to the attacker making the frontal assault.

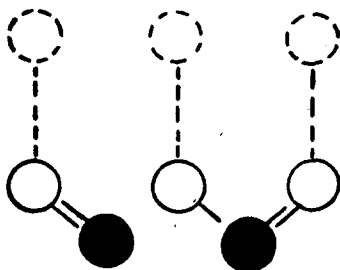

BAYONET

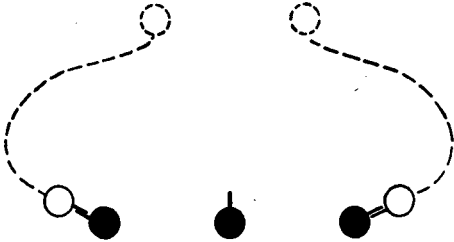

c. **TWO AGAINST THREE** In a situation where two bayonet fighters are confronted by three of the enemy, they dart to the flanks, leaving the enemy in the center the last to be encountered. When one of the attackers has disposed of his opponent, he immediately attacks the remaining enemy.



d. **ONE AGAINST TWO** Where two of the enemy confronts one soldier, this man darts forward and immediately turns to the flank of one or the other enemy.



Under no circumstances does he permit himself to be caught between them. By moving quickly to one side or the other, whichever is more expedient, he keeps the nearer enemy between himself and the farther enemy, and concentrates on disposing of one enemy at a time.

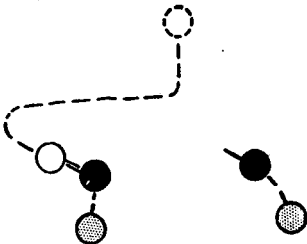

SECTION IV

BAYONET AND KNIFE DISARMING

16. GENERAL a. The soldier who in combat becomes unarmed because of a lost or useless weapon, is not helpless. He does one of two things: he immediately secures another weapon, *any weapon*, and continues to fight; if this is not possible, he disarms his opponent and kills him with his own weapon.

b. The temporarily unarmed fighter reacts just as aggressively as if he were armed. With his eyes, his brain, and his muscles he gets set for a timed, close-in attack. The *time* is that instant when the opponent has charged, or committed himself to a thrust from which he is unable to recover or to counter the unarmed fighter's sudden maneuver.

c. The basic principles in disarming are:

- (1) Do not "telegraph" or give away the intended disarming movement to the attacker before he charges.
- (2) Whatever the movement used, use it at the last possible moment and at top speed.

d. The disarming movements described herein are simple maneuvers. Through training they become in-

BAYONET

stinctive. If the soldier does not immediately succeed in wresting the enemy's weapon from him, several supplementary attack movements may be employed effectively. Such movements include—

(1) Kneeing him in the groin and kicking him in the knee, shin, or instep.

(2) Hitting him with the elbow, fist, and heel or outer edge of the hand on the face, throat, neck, or solar plexus.

(3) Jabbing his eyes or throat with stiff fingers.

(4) Suddenly throwing anything at the eyes of an armed attacker, as he closes in, that will distract him momentarily and provide an opening for the disarmer.

17. BAYONET DISARMING a. FIRST METHOD

With the right hand, parry the opponent's bayonet to the *left*, at the same time side-stepping to the right. With the *left* hand, palm up, grasp the rifle between the bands. Then with the outer edge of the right hand, strike the inside of the attacker's left elbow and grasp his upper forearm. Keeping a firm hold on the rifle, move quickly past the attacker on his left, jerking the rifle up and backward in an arc over his shoulder. If he still retains his hold on the rifle, kick and hit him, yanking the piece loose; whirl, and attack him with the bayonet.

b. SECOND METHOD With the left hand, parry the opponent's bayonet to the *right*, at the same time side-stepping to the left. With the right hand, palm up, grasp the rifle between the bands. Then with the left hand, palm down, grasp the receiver and jerk the piece sharply up and backward in an arc over the attacker's

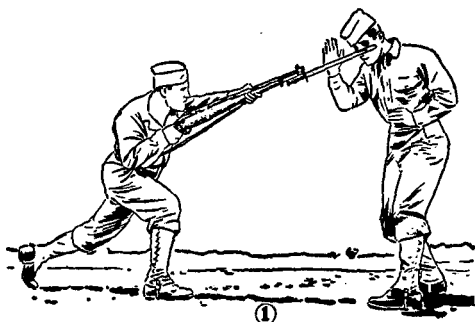

FIGURE 15.—To disarm an opponent, following a right hand parry.

shoulder. Keeping a firm hold on the rifle with both hands, move quickly past the attacker, twisting the rifle out of his hands; smash him with the butt, or whirl and attack him with the bayonet.

18. KNIFE DISARMING a. GENERAL To disarm an opponent armed with a knife, the basic actions are to deflect the knife and immediately apply pressure, or a blow, to cause the attacker to release the knife. The disarming movements described are those which the soldier uses to meet a right-handed attacker. For a left-handed attack, the directional movements of the disarmer are reversed.

b. OVERHAND ATTACK With the left forearm, block the knife arm before it becomes extended. The forearm is bent at the wrist to prevent the knife arm from slipping sideways. Bring the right foot forward, driving the knee into the groin, or, if that is not possible, stepping past to protect the front of the body. Carry the right forearm under and behind the opponent's upper arm and grasp your left wrist with the right hand. Backward pressure will cause the opponent to drop the knife and will probably break the elbow.

c. UNDERHAND ATTACK Side-step quickly to the left outside of the thrust and knock the knife arm to the side with the left forearm. With the right hand, grasp the opponent's right wrist, and at the same time bring pressure on the right elbow with the left hand or forearm. As the opponent's wrist is twisted, the left hand continues to put pressure on the right elbow from above. By placing a leg in front of the opponent's near-

BASIC FIELD MANUAL

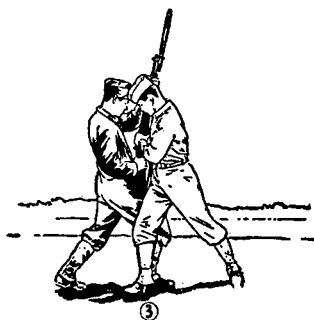
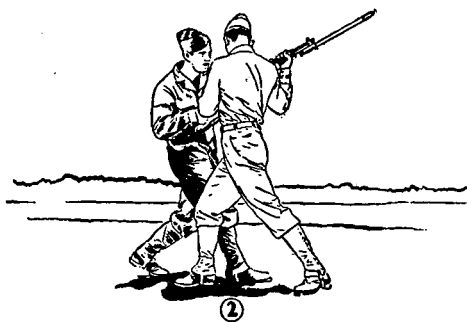
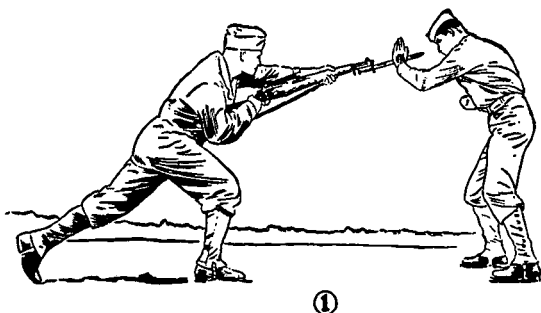

FIGURE 16.—To disarm an opponent following a left hand parry.

BAYONET

est leg, you are in a position to kick out the leg and throw him to the ground.

d. **AGAINST OTHER TACTICS** Against a knife fighter who does not use overhand or underhand thrusts or slashes, but moves his weapon in swift arcs in all directions, disarming tactics are extremely difficult if not impossible. Against such an opponent, it is best to keep out of range of his blade and to attack him by throwing anything at his face and kicking at his knees, meanwhile keeping alert for an opening to get inside the range of his weapon.



BASIC FIELD MANUAL

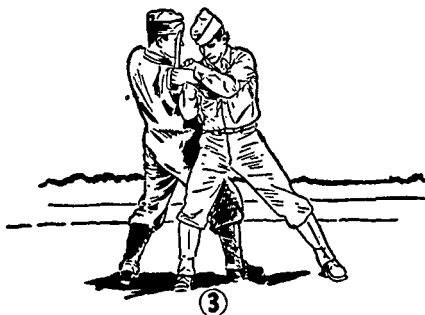
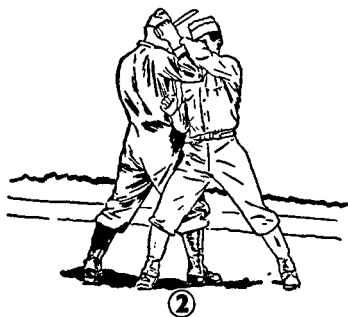

FIGURE 17.—To disarm an opponent who uses overhand attack.

BAYONET

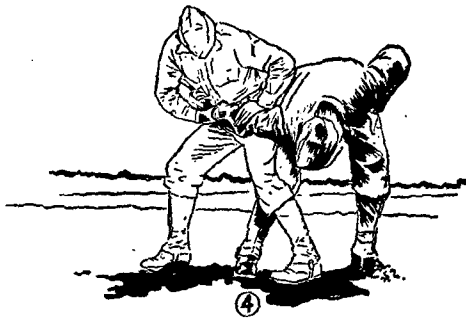
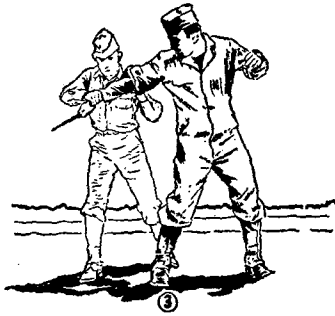

FIGURE 18.—To disarm an opponent who uses underhand attack.

SECTION V

ADVICE TO INSTRUCTORS

19. THE INSTRUCTOR a. The instructor should have a good physique and be able personally to demonstrate all the positions and movements. He must possess an intense enthusiasm, vigor, and those qualities of leadership which will inspire the best efforts of the men being trained. These qualities, or their lack, will be reflected in the efforts of the men.

b. The instructor impresses upon the men that the bayonet fight may be the culmination of a gruelling advance or a determined defense under conditions when men approach exhaustion. Therefore, throughout the training, he emphasizes continued driving forward with the bayonet by sheer power of will even though the body may be ready to collapse.

c. The instructor avoids boisterous, bullying, impatient methods. He uses a clear, earnest, and encouraging delivery to secure alert and willing response.

d. The instructor does not use or encourage the use of profanity to instill fighting spirit. He encourages

BAYONET

spontaneous yelling but does not demand forced yelling. Noise is no substitute for enthusiasm or ability.

e. Men must be in good physical condition before commencing bayonet training. Further conditioning is progressive. To obtain best results the instructor does not permit the men to become unduly muscle-sore.

f. Explanations and demonstrations are concurrent. They are brief and clear. The instructor and assistants first demonstrate at full speed; then at slow motion, broken down and analyzed so that the details of the movement are clear to the pupils.

g. The instructor stresses speed, balance, timing, and judgment of distance. Since tenseness counteracts all those qualities, he emphasizes relaxation of muscles.

h. Each man must think and act for himself. Therefore, the instructor avoids the harmful practice of turning bayonet work into a drill. Training by command should be used only at the start of the training. As quickly as possible, training should be by coach-and-pupil methods, in order to insure eye and muscle coordination, without command.

i. Teamwork is instilled in the men during instruction in group assault tactics and on the assault course. (See pars. 24 and 25.)

20. CONDUCT OF CLASSES a. MASS FORMATION A mass formation; preferably of not more than 200 men, may be used during training in the fundamentals of bayonet technique, positions, and movements. The formation is similar to that used in massed calisthenics except for increased distances and intervals be-

tween men. This formation will frequently be found advantageous in order to utilize the services of an instructor of outstanding qualities of leadership who can imbue a mass with enthusiasm and effort. Trained assistants aid in making corrections. Backward men are taken out of the formation for additional instruction.

b. GROUP FORMATION (1) For bayonet training in platoons or smaller groups, the men form in two ranks at normal interval. The instructor designates one man in the rear rank as "base man," who immediately assumes the position of HIGH PORT. The instructor then commands: 1. FORM FOR BAYONET TRAINING, THIS MAN (pointing) BASE, 2. MOVE. At the command MOVE, the base man assumes the guard position. The remainder of the men of the rear rank run to the right and left, respectively, to secure 3-pace intervals, face to the front, and assume the position of GUARD. Each front rank man runs by the shortest route to a position about 10 paces from and immediately in front of his rear rank file, whirls about, and assumes the position of GUARD. While moving to positions all men carry rifles at HIGH PORT.

(2) To assemble the group, the instructor commands: 1. ASSEMBLE, 2. MARCH. At the command MARCH, the base man originally designated assumes the position of "attention." All others form on him at a run and assume the position of "attention."

(3) To form for more detailed instruction, being in two ranks facing in as described in (1) above, the instructor stands at one end of the formation and directs the opposite ends to close toward the center, producing a three-sided formation. This position is suitable for conducting a conference or demonstration that can be

BAYONET

seen and heard by the entire group. Upon completion, the instructor directs "Back to your places."

c. **EMPLOYMENT OF TRAINING STICK** As soon as working knowledge of positions and movements has been learned, either in a mass formation or in platoon or smaller group formations, the men continue to practice working in pairs as coach and pupil, using the training stick. (See par. 23d.) In handling the training stick, the coach is speedy and aggressive. He moves fast in offering logical targets at proper distances and avoids restricting the pupil's freedom and vigor of movement. He is on the alert to detect and correct errors made by the pupil. The coach-and-pupil method permits individual instruction, provides variety in the frequent interchange of duties, and affords an excellent means of developing coordination in both coach and pupil. (See FM 21-5.)

d. **QUICKENING EXERCISES** Five or ten minutes devoted to quickening exercises at the beginning of training periods relax the men and help to develop coordination of muscles used in bayonet combat. The exercises may include boxing, wrestling, personal contests, and group games involving teamwork. (See FM 21-20.) Calisthenics are not recommended for this purpose.

21. SEQUENCE OF TRAINING The following sequence is suggested at the *beginning* of bayonet training. Periods should not exceed 50 minutes.

a. FIRST PERIOD

- (1) Lecture: *Spirit of the Bayonet*.
- (2) Positions and movements.

BASIC FIELD MANUAL

- (a) Guard and short guard.
 - (b) High port.
 - (c) Whirl.
 - (d) Long thrust and withdrawal.
 - (e) Short thrust and withdrawal.
- (3) Practical work under centralized control in mass formation or in platoon or smaller groups under assistant instructors.

b. SECOND PERIOD

- (1) Review previous lesson.
- (2) New movements.
 - (a) Vertical butt stroke and return to guard.
 - (b) Horizontal butt stroke and return to guard.
 - (c) Parry right, thrust, withdrawal; against each other advancing; repeated on the run.
 - (d) Parry left, vertical butt stroke; against each other.

c. THIRD PERIOD

- (1) Review previous lessons.
- (2) New movements.
 - (a) Vertical butt stroke series.
 - (b) Horizontal butt stroke series.
 - (c) Thrusting at swinging dummies from a halt and from a walk.

d. FOURTH PERIOD

- (1) Review previous lessons.
- (2) Training sticks—introduction.
- (3) Thrusts and parries with training stick—coach and pupil—without scabbards.
- (4) Thrusting at swinging dummies from a run.

BAYONET

e. FIFTH PERIOD

- (1) Review (practice thrusts and parries with the training stick).
- (2) Butt strokes with the training stick.
- (3) Group assault tactics—two against one—with scabbards.
- (4) Parries and thrusts at dummies from a run.

f. SIXTH PERIOD

- (1) Review all movements with training stick.
- (2) Group assault tactics:
 - (a) Two against one.
 - (b) Three against two.
 - (c) Two against three.
 - (d) One against two.
- (3) Assault course, at a walk.

g. SEVENTH PERIOD

- (1) Review.
- (2) Assault course, at a run.

h. EIGHTH PERIOD

- (1) Review.
- (2) Assault course, at a run.

i. NINTH PERIOD

- (1) Disarming, bayonet and knife.
- (2) Assault course, at a run.

j. TENTH PERIOD

- (1) Review disarming, bayonet and knife.
- (2) Assault course, at a run, with pack and haversack.

k. Continuing and repeated periods of bayonet prac-

tics are necessary to train and keep the bayonet fighter in condition. These periods should follow the basic training outlined above. Twenty minutes of practice during 3 days of each week are required to maintain form and physical perfection. Emphasis during such periods will be placed on assault course practice and other training procedures of a varied and vigorous nature.

22. CONDUCT OF TRAINING a. Front sight covers for rifles so equipped will always be attached for bayonet training.

b. The pupil first practices movements in slow motion, rather than by the numbers, to acquire form and precision. He then increases his pace in order to develop progressively greater speed and aggressiveness.

c. Initial training in parries includes the actual parrying of an opponent's piece to acquire a sense of distance, force, and timing. The men work by the coach-and-pupil method in two ranks. Both ranks have rifles with bayonets fixed and scabbards on. The instructor directs the coaches to thrust at half speed. The pupils, in the other rank, parry right and thrust, or parry left and thrust, or butt stroke at half speed. After practicing for about 1 minute at will, the instructor directs the coach and pupil to reverse their relation. He supervises and controls the exercise to detect errors, to avoid sparring tactics, and to give equal practice to both ranks. He limits this exercise to brief periods only.

d. As soon as men attain a degree of proficiency in positions and movements, they use the training stick. Its purpose is to give the soldier a small target which

BAYONET

he can attack with speed, force, accuracy, and aggressiveness without endangering the coach. The pupil uses the bare bayonet so that both coach and pupil will become accustomed to seeing it.

e. Training on the swinging dummies emphasizes judgment of distance, balance, and force. The instructor stresses full extension of the body and piece to attain a maximum reach.

f. Practice in group assault tactics and on the assault course develops the essential element of teamwork.

g. Throughout bayonet training the instructor trains the men to see and strike instantly at any opening, thus developing coördination between eyes and muscles, and mental and physical alertness. He combats all tendencies toward tense, mechanical, plodding motion and slow reaction to sudden situations.

h. Instructors may improvise training techniques which will assist in developing the essential qualities of the bayonet fighter and add them to the training procedures outlined herein.

23. TRAINING AIDS a. DUMMIES Dummies of various types should be constructed as an aid to training. (1) Thrusting dummies can be made by pressing suitable materials, such as cane, willow, bamboo, swamp grass, or small brush, into a rectangular form approximately 36 by 12 by 9 inches. This material is bound together with wire or rope, a heavy cardboard placed on one side, and the bundle covered with burlap or other suitable material.

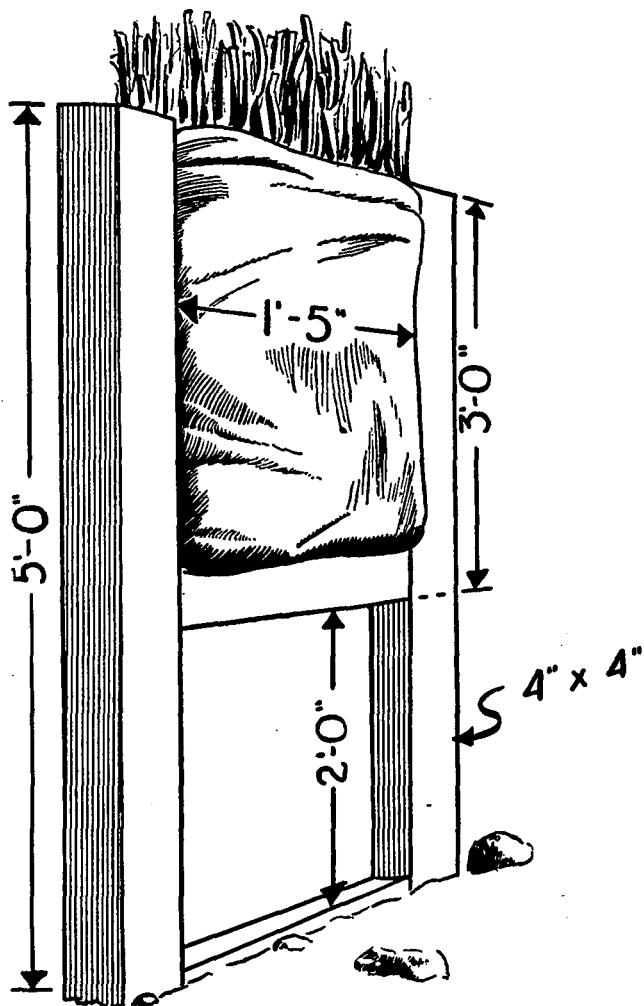
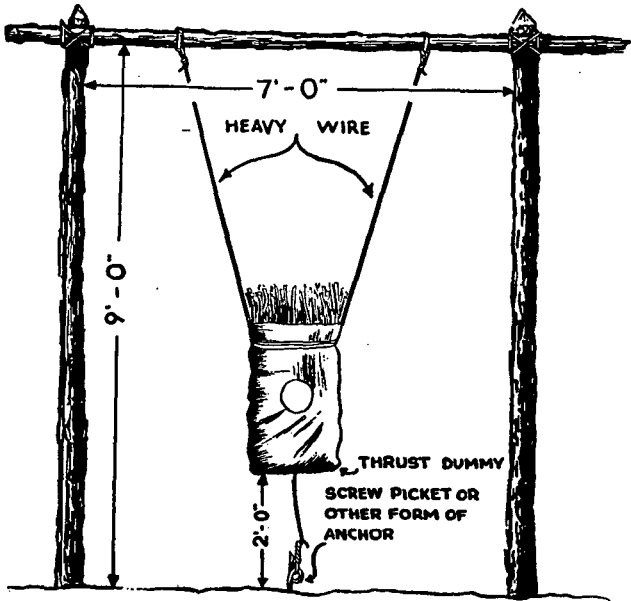

FIGURE 19.—Thrusting dummy. (1) Dummy in fixed frame.

BAYONET



(2) *Swinging dummy and frame. (May be made free-swinging for advanced training by disconnecting anchor.)*

(2) Suggested frames and their specifications are shown in figures 19, 20, and 21.

(3) Where the construction of thrust dummies is required in large quantities, some mechanical method of construction should be improvised. For details of construction of a hand-power press, see figure 22.

(4) Details of construction of the vertical butt stroke dummy are shown in figure 23.

(5) The horizontal butt stroke dummy is made by stuffing heavy cloth or burlap bags with some light material

such as straw or old rags. For details of construction, see figure 24.

(6) Additional dummies for use on the assault course, and suggested types of obstacles, include those shown in figures 25 to 35, inclusive. (See par. 25.)

b. SWINGING DUMMIES When the techniques of the LONG THRUST and SHORT THRUST have been learned, the men practice thrusting at paper disks or

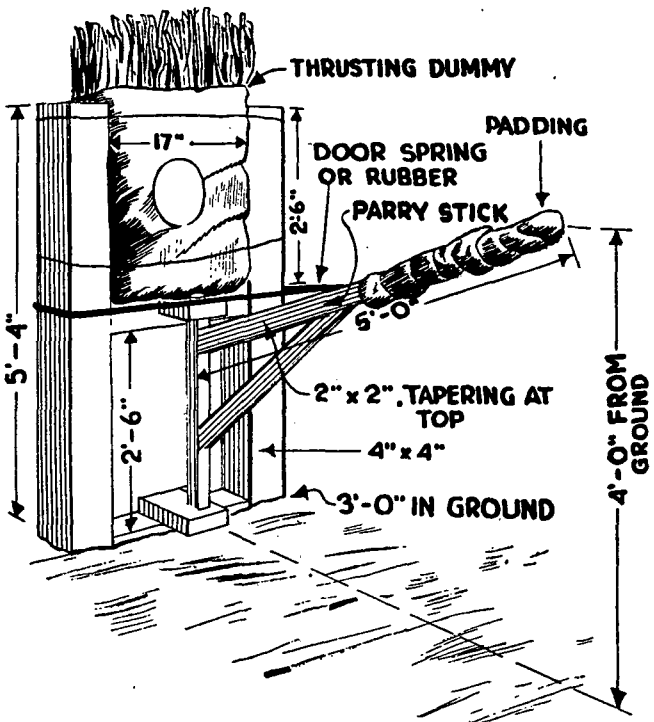

FIGURE 20.—Parry and thrusting dummy.

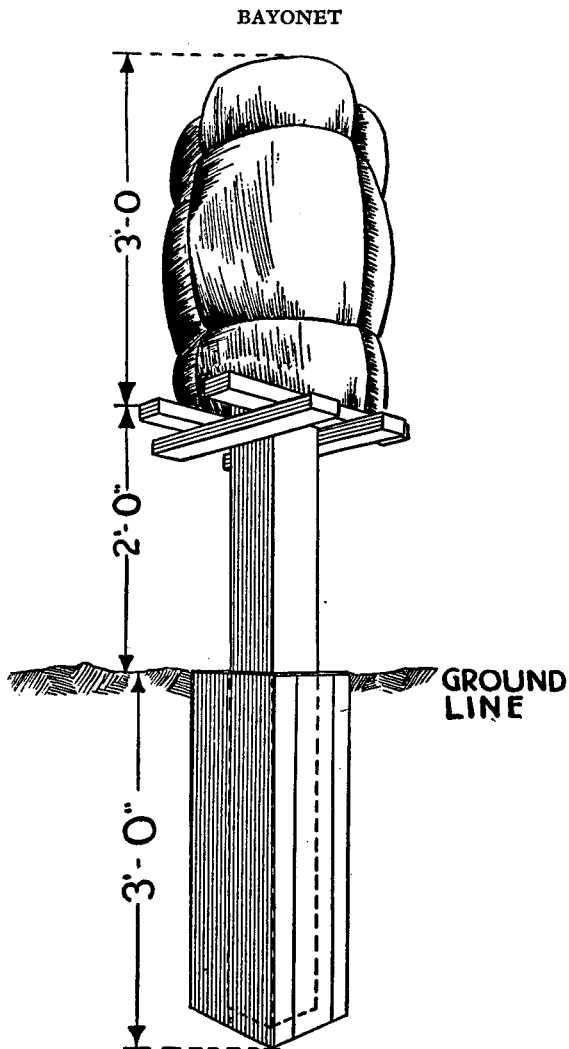

FIGURE 21.—Movable thrusting dummy
(with ground frame).

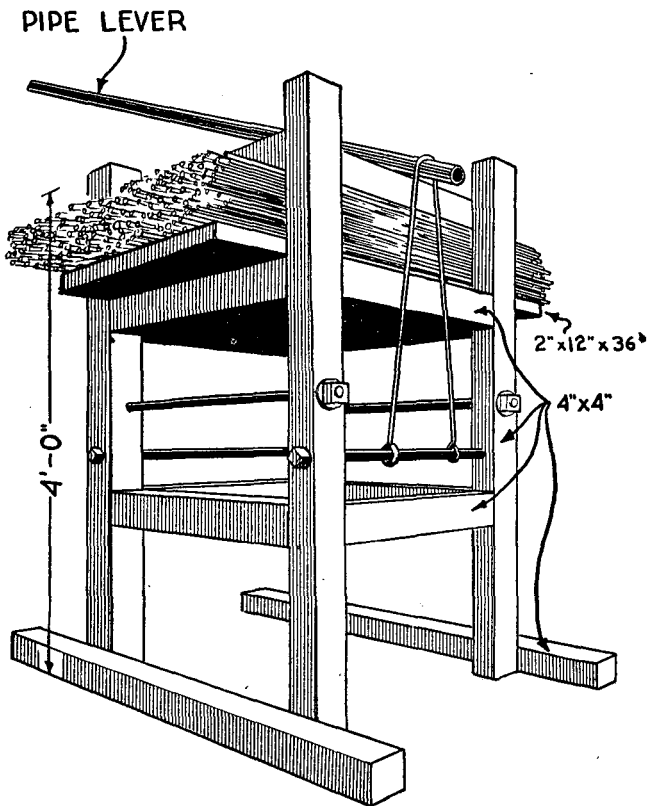

FIGURE 22.—Press for construction of thrusting dummies.

circles painted on swinging dummies. Groups consist of not more than six or eight men per dummy. They remove scabbards and proceed as follows:

(1) The soldier scratches a take-off line on the ground for the first few thrusts. He makes a full extension of

BAYONET

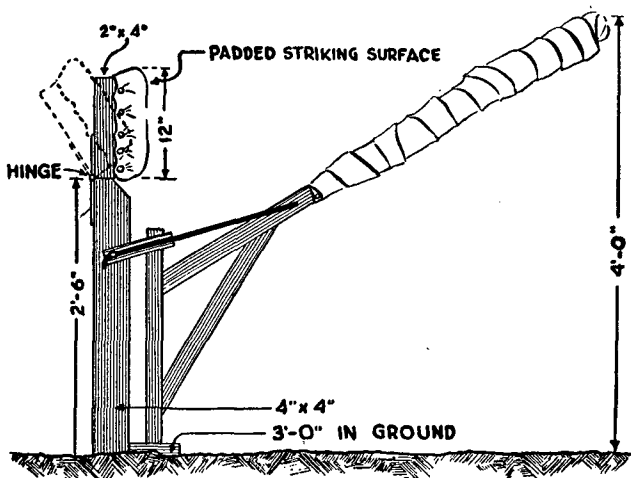

FIGURE 23.—VERTICAL BUTT STROKE *dummy*.

the body and rifle in a correct LONG THRUST, to determine the proper location of this line. The position of the leading foot is the location of the take-off line. He discontinues the use of the take-off line as soon as he learns the range of his thrusts, since its continued use will cause him to concentrate on his feet rather than on executing a proper thrust.

(2) The soldier first executes the thrust from a halt. He then executes it after advancing several paces. He gradually increases the distance and speed of advance. Finally, he makes the advance at a run from a point about 20 paces from the dummy. When he is about 5 paces from the dummy he assumes the GUARD position before executing the thrust. He advances in a practical

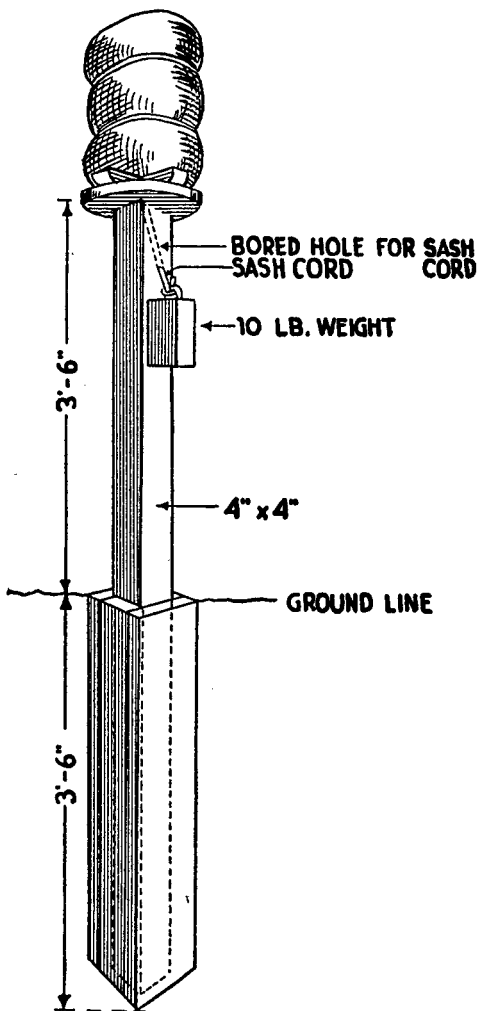

FIGURE 24.—Movable HORIZONTAL BUTT STROKE dummy (with ground frame).

BAYONET

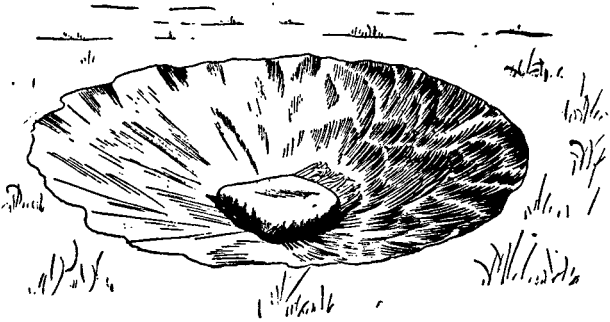

FIGURE 25.—Prone dummy to be attacked.

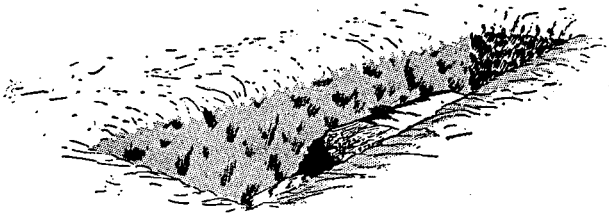

FIGURE 26.—Individual prone shelter with prone dummy to be attacked.

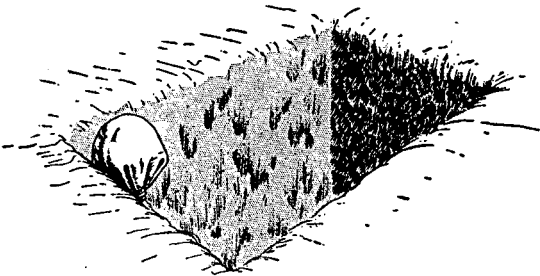

FIGURE 27.—Fox hole with exposed head. To be attacked by a thrust.

BASIC FIELD MANUAL

VARIABLE HEIGHTS --27" MAX.
VARIABLE INTERVALS

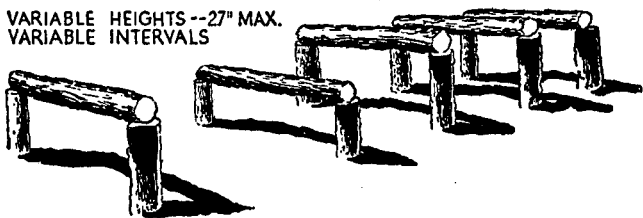

FIGURE 28.—Hurdles to be stepped over.

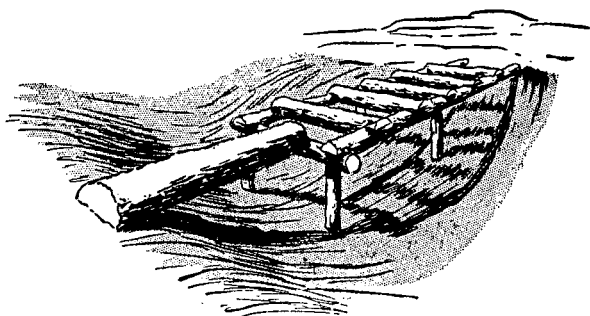

FIGURE 29.—Log balance and horizontal ladder.

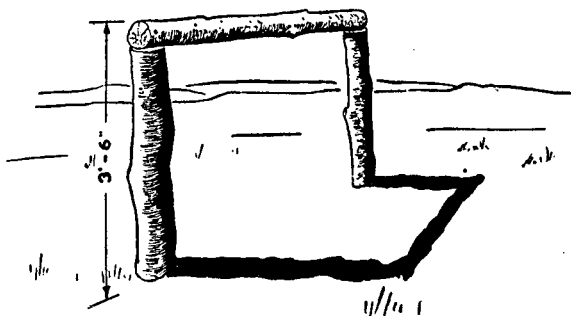

FIGURE 30.—Fence vault.

BAYONET

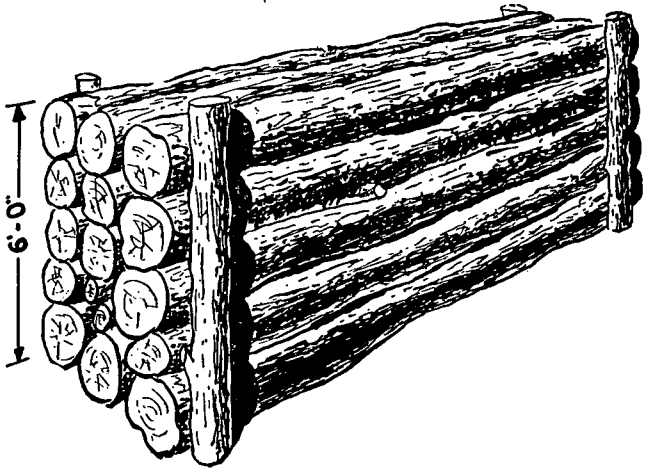

FIGURE 31.—Wall scale.

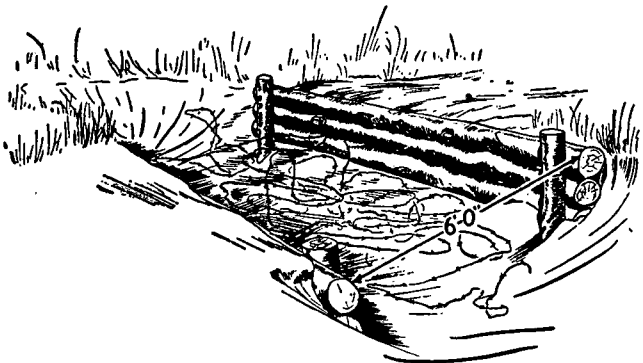

FIGURE 32.—Ditch jump.

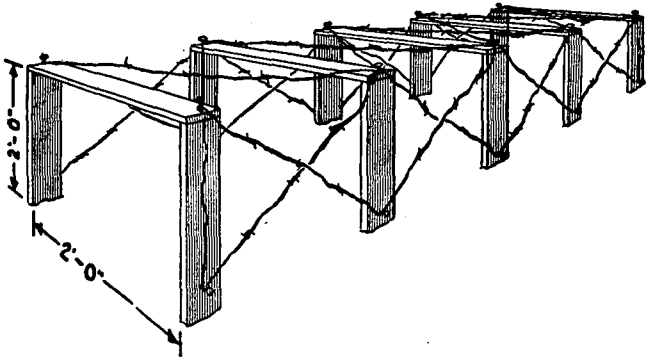

FIGURE 33.—Tunnel crawl.

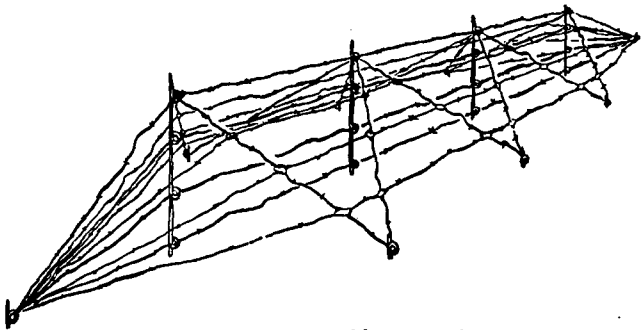

FIGURE 34.—Double apron fence.

and natural way, without regard to which foot is to the front when making the thrust.

(3) After mastering the procedure outlined above, the soldier will execute a long thrust at one circle and one or several short thrusts at other circles in quick succession.

c. WITHDRAWAL BOARDS

(1) The instructor uses withdrawal boards to teach the

BAYONET



FIGURE 35.—Surprise dummy, to be hung from any tree limb along the assault course. This dummy is to be attacked by the soldier at the moment that it is dropped in his path. More than one such dummy may be used.

use of the weight of the entire body in making a withdrawal when the bayonet has become tightly imbedded.

(2) The boards may be any pieces of lumber $\frac{1}{2}$ to 1 inch thick, 4 inches wide, and $1\frac{1}{2}$ to 2 feet long, placed on the 4 by 4 swinging dummy uprights by nailing or screwing the lower end of the board to the upright about $3\frac{1}{2}$ feet from the ground.

(3) The pupil inserts his bayonet, scabbard removed, between the board and upright. The coach presses the upper end of the board so that the bayonet is clamped. The difficulty of withdrawal illustrates the necessity for proper technique.

d. TRAINING STICK

(1) The training stick is made from any light piece of wood about 6 feet long and 1 inch thick. One end is padded with cloth or waste; a 5-inch loop of stiff rope or insulated thick wire is attached to the other end.

(a) When the coach places either end of the training stick on the ground, the pupil immediately assumes the GUARD position (fig. 36(1)), and threatens the coach with his point as long as he is close enough to attack. The coach then offers either end of the stick in varying positions.

(b) If the ring is presented, the pupil attacks either with a long or short thrust, as indicated by the distance between his point and the stick (fig. 36(2)). If the ring is holed, the withdrawal is made and the position of guard resumed, or the attack continued if another target is offered.

(c) If the padded end of the stick is *thrust* at the pupil (fig. 37(1)), he executes a right or left parry (fig. 37(2)). Care will be exercised that the coach does

BAYONET

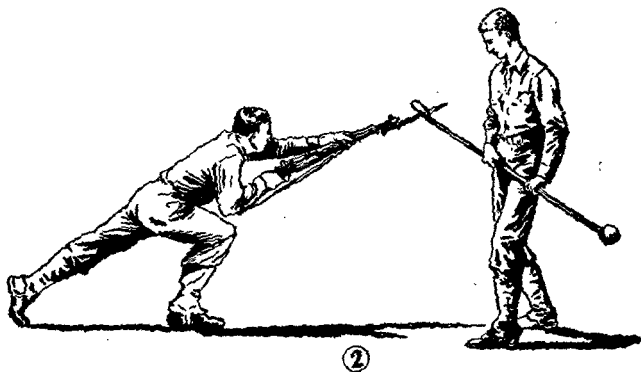

FIGURE 36.—Thrusting at ring of training stick.

BASIC FIELD MANUAL

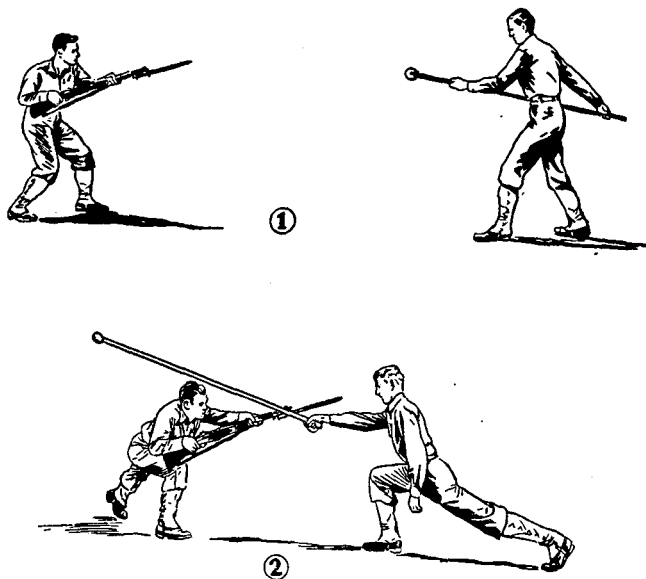

FIGURE 37.—Thrusting at padded end of training stick.

not swing the stick into the pupil. If sweeping movements are made with the stick, the pupil will probably develop a sweeping parry.

(d) If the coach *presents* the padded end of the stick, the pupil delivers a butt stroke at it. If this is a miss, he comes on with a smash and slash until he hits the padded end. As soon as he hits it, he resumes the **GUARD**, or continues the attack if the coach continues to offer a target.

(2) To develop the pupil's accuracy in hitting a target, the coach initially lets the pupil penetrate or strike the target. As the pupil attains accuracy and speed, how-

ever, the coach draws the target away to cause the pupil to miss. The coach then quickly places the target to indicate the next attack. Whenever the pupil pierces the loop in a thrust or strikes the padded end in a butt stroke, he automatically assumes the GUARD position, ready to continue the attack.

(3) For PARRIES, the coach holds the training stick at the loop end in the manner of a pool cue, with the padded end toward the pupil. The coach stands about 12 feet in front of the pupil. Guiding the stick initially with his left hand, the coach thrusts the padded end directly at the pupil's head or body, lunging forward as he thrusts. The pupil parries the stick in the most expedient direction. The coach immediately follows up by presenting a suitable target for the attack which must follow the parry.

24. TRAINING IN GROUP ASSAULT TACTICS

a. GENERAL Training in group assault tactics will not begin until the soldier has become proficient in bayonet technique. The men practice group assault tactics in groups of three and five, with fixed bayonets covered with scabbards. The movements are gone through as in actual combat, except that the represented enemy is struck lightly, simulating the actual killing blow. Individuals who simulate the enemy in group assault practice will not take the offensive, but will remain on the defensive in order to illustrate plainly to the attacker the principles and tactics involved. When the enemy (or any attacker) has been touched on the body by the opponent's bayonet, he drops to one knee

and remains out of action until that bout terminates. After the principles have been learned, the men rotate so that each fights in every position several times. Initially, practice will be at half speed, emphasizing position and coördination. When the men acquire these essentials, they accelerate the pace to top speed.

b. **SEQUENCE OF TRAINING** Group assault tactics will be practiced in the following sequence (see par. 15):

- (1) Two against one enemy.
- (2) Three against two of the enemy.
- (3) Two against three of the enemy.
- (4) One against two of the enemy.

25. ASSAULT COURSE a. **PURPOSE** A qualification course requiring the execution of fixed sequences of movements to achieve a score in points as an indication of proficiency of the bayonet fighter has been eliminated from bayonet training. Assault course practice incorporated in the sixth and subsequent periods of training (see par. 21) accomplishes the following:

- (1) It provides practice in bayonet fighting under conditions approximating combat conditions.
- (2) It aids the bayonet fighter to develop speed, strength, and endurance.
- (3) It offers a challenge to the soldier's determination and will power which are so essential in combat.
- (4) It provides a means of instilling habits of group action and teamwork in assault tactics.
- (5) It furnishes a gage of proficiency in bayonet fighting.
- (6) It provides a means for maintaining a state of pro-

BAYONET

iciency by continued periodic training, including practice after hours.

b. DESCRIPTION

(1) Assault courses should be laid out on rough terrain, preferably wooded. The length of the course may vary from 200 to 300 yards. The number and type of obstacles on the course will depend upon local conditions and the ingenuity of the builder. The builder should make effective use of natural obstacles, such as streams, ravines, ridges, and thick woods. He should improvise artificial obstacles, such as trenches, ditches, craters, wire entanglements, fences, log walks, hurdles, and horizontal ladders.

(2) Targets should consist of logically placed dummies, preferably movable, so that the course can be altered frequently. The builder should place surprise targets at various points, and suspend dummies from trees to swing out as the attacker approaches. He may hinge others to swing out from behind trees or thickets. He can build thrusting and butt stroke dummies with 4- by 4-inch timbers, set into boarded holes. He can move the dummies by placing similar holes at different points on the course. He should include several targets for employment of group assault tactics.

(3) The course should have six lanes, permitting one-half squad to run the course under the squad, assistant squad, or other designated leader.

c. RUNNING THE COURSE

(1) Because of variations in local terrain and differences in the placement of obstacles and dummies, there should be no fixed time limit. The soldier first runs the course

at a moderate pace, and increases the speed as his technique and physical condition develop.

(2) The instructor insures discipline and organized control. He designates one man in each assaulting group as the leader, and the group operates as a team.

(3) The instructor and his assistants will be stationed along the course to observe the methods of attack and to make corrections, when necessary.

26. BAYONET AND KNIFE DISARMING a. Practice in disarming methods will not be undertaken until the soldier has had thorough training in bayonet fighting, since the instinctive movements and basic principles of bayonet fighting form the basis for disarming techniques. This practice will follow the *initial* training in group assault tactics and in running the assault course.

b. The instructor should first conduct practice in bayonet disarming with scabbards on; or in the case of knife disarming, with empty scabbards or sticks representing knives. As the men gain proficiency and confidence, they will practice with bare blades.

c. The skill and speed necessary in the execution of disarming tactics will be acquired through frequent practice periods of brief duration. However, since disarming is an expedient rather than a basic method of combat, time will not be devoted to this training at the *expense* of training in bayonet fighting.